

MT200-GPS

# Positioning tracker

**User Manual**



# content

## 1. Product Overview and Appearance Introduction 3

- Product specifications 3
- button 3
- Function indicator light 4
- the belt 4
- Accessories 5

## 2. First use 5

- How to use the belt 5
- Charge 7
- turn on/off 8
- Parameters set up 9

## 3. Instruction and function applications 9

1. Change password 9
2. Authorized number 9
3. Monitoring function 11
4. Two-way communication 11
5. SOS emergency calling 11
6. Real time tracking 11
7. Tracking regularly by GPRS 12
8. GPRS data logger 13
9. Geo-fence 13
10. Time zone setting 14
11. Low battery alarm and Power on/off automatically 14
12. Timing turn on/off tracker 14
13. Belt on/off alarm 15
14. Leave the home alarm 15

## 4. Problems & Diagnostics 16

# 1. Product Overview and Appearance Introduction

The GPS Tracker has the advantages of **waterproof IP67**, low power consumption, Long Standby Time(22-24 days) and easy to use. apply to correct the crowd.

## Product specifications

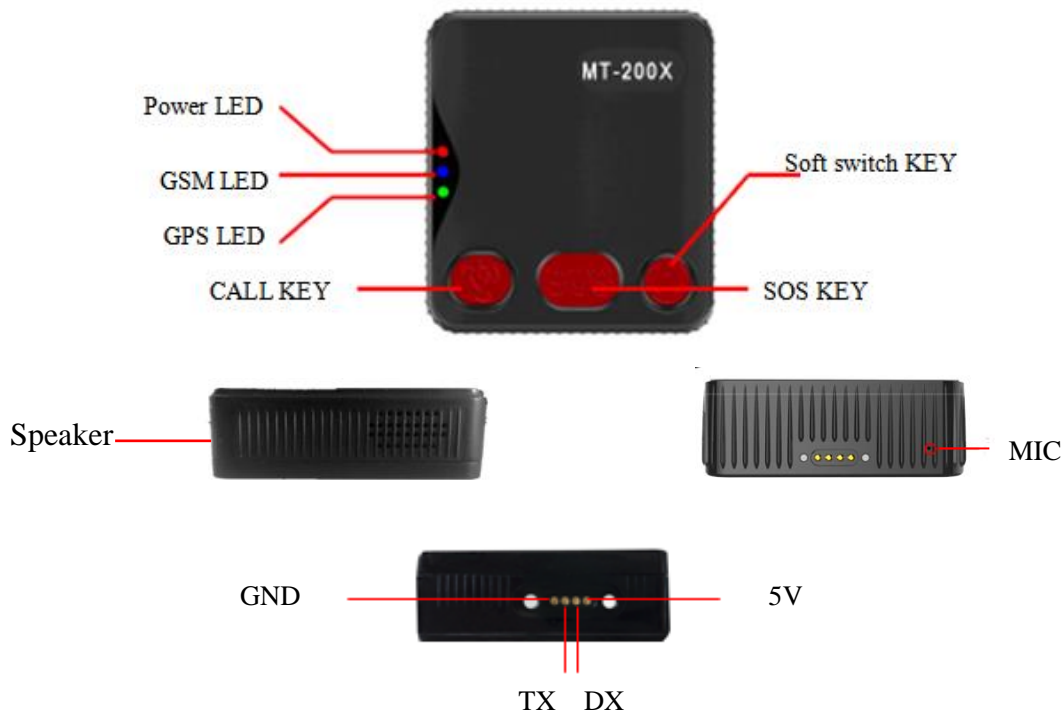

## button

Button	
Soft switch key	<ol style="list-style-type: none"><li>1. Press for 1s to determine the low power, When the green light, the battery power is less than 15%;</li><li>2. When the short press blue light and green light at the same time, when the battery power at 15% -100%.</li><li>3. Press for 5s, vibration, turn on.</li></ol>
CALL key	Press for 1s to pick up a call, press for 3s to call to an authorized number (vibration touch for calling)
SOS key	Press it for 3s to send an alarm SMS with coordinates

## Function indicator light

### Red/yellow – Power indication

The red light is always on      Power charging

The green light is always on      Power charging finished

### Blue – GSM indication

0.3s on and 0.3s off      GSM module is initializing or calling in

Always on      GSM network is not registered

1s on and 3s off      GSM network is registered

0.1s on and 3s off      GSM network is registered and connected to the server by GPRS

Always off      GSM in power save mode

### Green – GPS indication

0.3s on and 0.3s off      GPS module is initializing or waiting for the SOS button press to

Always on      Button being pressed

1s on and 3s off      GPS module is working normally but hasn't fixed position

0.1s on and 3s off      GPS module is working normally and has fixed position

Always off      GPS module stops working

## the belt

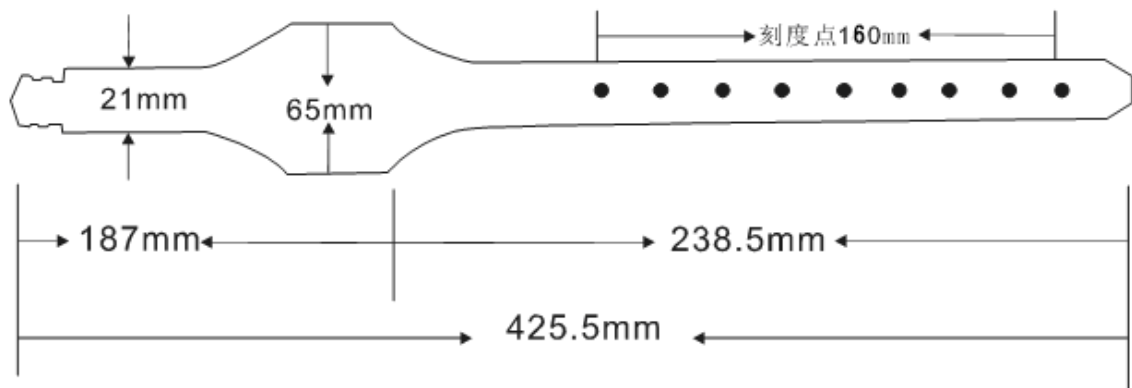

## Accessories



Screw driver



Charge cable



micro Charge cable



Power Bank



AC adapter

## 2. First use

### How to use the belt

#### —Install the card requirements

- Ensure that your tracker has a working SIM card.



SIMCARD



microSIM



nanoSIM



- Please make sure SIM card has enough credit.
- Please make sure that the SIM is not locked and do not require a password to operate.
- Please make sure the SIM card is supporting caller ID display.

#### —Install the card steps:

①

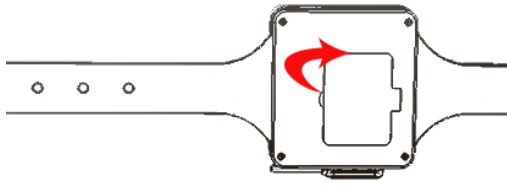

1、 open the Rubber back cover

②

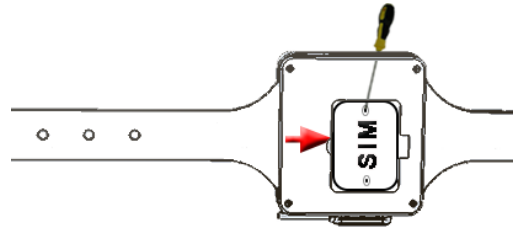

2、 Open the SIM card cover with a screwdriver

③



3、 Open the metal cover of the card slot, insert the SD card and SIM card, and fasten the metal card cover

4、 Install the SIM card cover and lock the screw

—adjust to suitable size and fixed the belt.

①

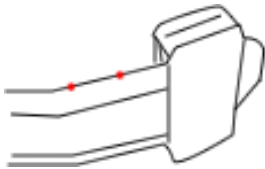

1、 Select the suitable size point

②

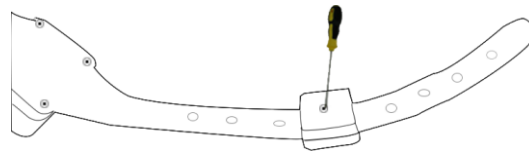

2、 Screwdriver fixed lock head

!!!Note: When the lock edge must be aligned with the size point, The screw can come into contact with the wrist strap

③

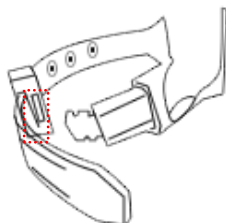

3、 Insert the plug into the lock

④

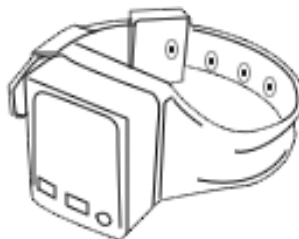

4、 Complete installation

—unlock the belt.

①

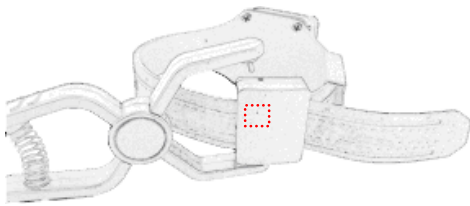

②

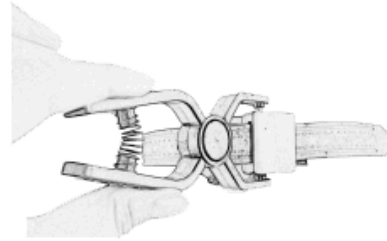

1、 The key is aligned with the locking hole      2、 press it on firmly.

③

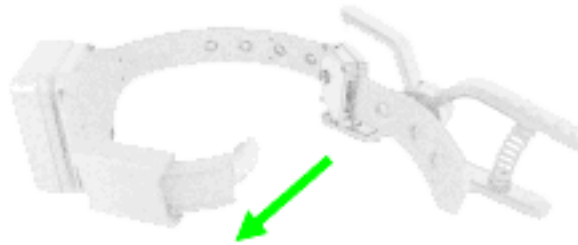

3、 opens the lock

## Charge

There are two ways to charge: using supplied AC adapter, power bank.

1、 Dedicated charging cable connection, the device is fully charged for 2.5-3 hours;

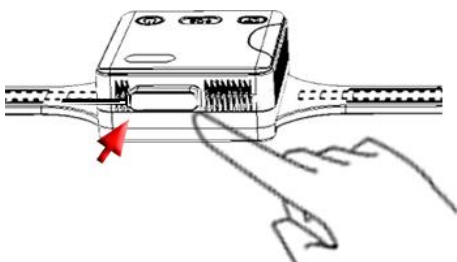

Dedicated charging cable connection

## 2 .Power bank charging

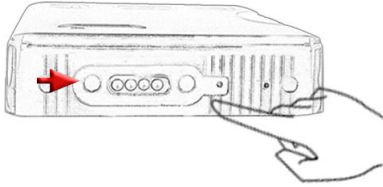

1、 Tracker charging interface



2、 Rechargeable contacts are connected to the charging interface of the tracker and The mobile power supply is mounted on the tracker.

## turn on/off

### 1、 power on

When you pull the switch that is after the SIM metal card cover, the machine can be powered on

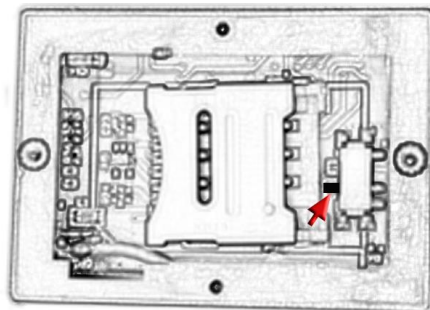

### 2、 soft switch button to turn on

①

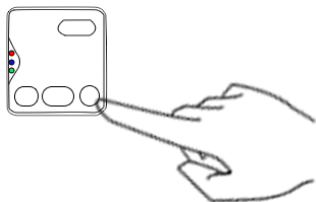

1、 Press soft key for 3 seconds

②

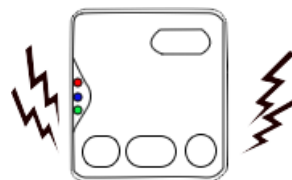

2、 Turn on or off after vibration

!!!Note: The tracker can be turned off when the wrist strap is disconnected



## Parameters set up

Tracker supports APP setup software by smart phone or by sending command via SMS or by pc. After setup, please turn the tracker on and positioning in an open environment, please do it every time after turn the tracker on.

## 3.Instruction and function applications

### 1. Change password

Description: change user's password

SMS Command: `$SMS, *****;W001, #####;!`

SMS Command explain: `$SMS, default password; W001,new password;!`

Explain:

\*\*\*\*\*: user password, the range of 6 digits, default password is 000000

#####: new password, the range of 6 digits.

**Note:** please switch to the English input method when you input a command by smart phone; tracker will only accept commands from a user with the correct password. Command will be ignored if with wrong password.

Example:

`$SMS, 000000;W001, 123456;!`

Read password: `$SMS, 000000;R001;!`

Clear password: `$SMS, 000000;C001;!`

### 2. Authorized number

**Set the authorized number by SMS**

Description: Set authorized phone number and its related functions

SMS Command: `$SMS, 000000;W010, NO. , Phone Number, ABC;!`

Explain:

NO.	authorized number's serial number	range of: 1~3
Phone Number	authorized number	range of: 0~19 characters
A	when the parameter 'A' is 0, it means disable Geo-fence alarm, otherwise it means enable Geo-fence alarm. Default is 0 range of: 0~1	
B	when the parameter 'B' is 0, it means disable monitoring function, otherwise it means enable monitoring function. Default is 0 range of: 0~1	
C	when the parameter 'C' is 0, it means disable SOS emergency calling function, otherwise it means enable SOS emergency calling function. Default is 0 range of: 0~1	

For example: Set the 1st authorized number is 13800000000 and enable monitoring function.

```
$SMS,000000;W010,1,13800000000,010;!
```

Read authorized No.1 and it's related authority: `$SMS,000000;R010,1;!`

Clear authorized No.1 and it's related authority: `$SMS,000000;C010,1;!`

Read all authorized number: `$SMS,000000;R010;!`

Clear all authorized number: `$SMS,000000;C010;!`

### **Easy authorized phone no. setup by calling**

Tracker only supports three authorized numbers; we can set the authorized number by phone call if there are not set authorized number fully (this function only supports to set the authorized number, not included its related functions).

Set as follows:

- 1、 Any non-authorized number calls to the tracker over than 10 seconds, the tracker will hang up the line automatically and the yellow light will blink for 30 seconds.
- 2、 During these 30 seconds, press SOS button less than 3 seconds, and then

successfully set this call-in number as a new authorized number and send an SMS to this number to inform the setting is OK.

### **3. Monitoring function**

If enable monitoring function, when the authorized number call to the tracker, it will answer the call automatically and shut down the speaker and the background voice of the tracker will be listened.

**Note:** Please make sure the SIM card installed supports displaying caller ID when you want to enable this function.

### **4. Two-way communication**

**The first method:**

If you turn the monitoring function off when set authorized number, use this authorized number call to tracker, bell will ring, at this time, press the CALL button (**less than 3s**) to answer the phone call, so you can speak each other.

**The Second methods:**

If the authorization number was set with the CALL function, Press SOS button for 3 seconds or longer, the device will make a call to authorized numbers one by one and it will stop to make a call if call is answered.

### **5. SOS emergency calling**

Press SOS button for 3 seconds or longer, tracker will send SOS alarm SMS to all authorized numbers.

### **6. Real time tracking**

The tracker will reply a location SMS if there is any authorized number makes a phone call to it.

## 7. Tracking regularly by GPRS

Description: Enable this function

SMS Command:

```
$SMS, 000000;W002, APN, Username, Password;W003, IP, Port;W005, X;W009, Y;!
```

Explain:

<b>APN:</b>	Access point name of network	range of: 0~29 characters
<b>Username:</b>	accesses port' user name	range of: 0~29 characters
<b>Password:</b>	Accesses port's password	range of: 0~29 characters
<b>IP:</b>	server' IP address	range of: 0~29 characters
<b>Port:</b>	server's port	range of: 0~65535
		range of: 0~65535, default is 0, unit is 30 seconds
<b>X:</b>	GPRS upload interval	Example: if X is 2, and $2*30s=60s$ , so it means the GPRS upload interval is 60 seconds.
		range of: 0~2
<b>Y:</b>	GPRS upload mode	0: means disable GPRS function, 1: means upload by TCP, 2: means upload by UDP default is 0

Example: 

```
$SMS, 000000;W002, cmnet, ;W003, 192.168.1.1, 8088;W005, 1;W009, 1;!
```

Read tracking regularly by GPRS:

```
$SMS,000000;R002;R003;R005;R009;!
```

Clear tracking regularly by GPRS:

```
$SMS,000000;C002;C003;C005;C009;!
```

## 8. GPRS data logger

Tracker has build in 8M bytes memory for GPRS data save.

- 1、 When GPRS interval tracking can not upload to server, data will be automatically stored in the memory
- 2、 After that, once the GPRS reconnected, tracker will send the data to server again.

Note: real time data will be sent first, the priority of the stored data is low.

## 9. Geo-fence

Description: Two ways to set the Geo-fence:

- 1、 When you know the exact latitude and longitude , the longitude and latitude can be filled in command directly.
- 2、 tracker will get the newest position automatically to be fence center if there is no available GPS position.

After set the Geo-fence:

when the tracker moves in/out the preset geo-fence, it will send a SMS alarm to the authorized phone number (enable the Geo-fence function when you set the authorized number), and if GPRS is connected, tracker will send this alarm data to server via GPRS.

SMS Command: `$SMS, 000000;W018, NO. , name, lat, lng, radius;!`

explain:

NO.	serial number of geo-fence, range of: 1 to 5
name	name of geo-fence, range of: 0-9 characters
lat	center's latitude, range of: -90.00000000~90.00000000, unit: degrees
lng	center's longitude, range of: -180.00000000~180.00000000, unit: degrees
radius	geo-fence's radius, range of: 0.0~1.79E+308, unit: meters

**Note:** The geo-fence is a perfect circle based on the preset radius and centre.

Example:

`$SMS, 000000;W018, 1, school, 22. 12345, 114. 12345, 10. 50;!`

`$SMS, 000000;W018, 1, home, , , 10. 50;!`

- 1、 Read Geo-fence: `$SMS,000000;R018,1;!`
- 2、 Clear Geo-fence: `$SMS,000000;C018,1;!`
- 3、 Clear all Geo-fence: `$SMS,000000;C018;!`

## 10. Time zone setting

SMS Command: `$SMS, 000000;W020, X;!`

Description: Set the SMS time zone

Explain:

X: time zone's value, range of:-720~780, default: 0, unit: minutes

For example:

`$SMS, 000000;W020, 480;!`

1 hour is equal to 60 minutes, and Beijing is GMT+8,  $60*8=480$ (parameter), so this command means 480 is the time zone in Beijing.

Read time zone: `$SMS,000000;R020;!`

Clear time zone: `$SMS,000000;C020;!`

## 11. Low battery alarm and Power on/off automatically

- 1、 When the battery level is lower than 15%, it will send SMS to all authorized numbers or send alarm data to server.
- 2、 Tracker will be off automatically if the battery level is 0%.
- 3、 during charging, tracker will automatically switch on when battery level is higher than 15%, and send a warning SMS to all authorized number.

## 12. Timing turn on/off tracker

Description: set the time of turn on/off

SMS Command: `$SMS, 000000;W038, on time, off time;!`

explain:

name	description	explain
on time	Turn on time	Range of: 00:00~23:59, default: 00:00。
off time	Turn off time	Range of: 00:00~23:59, default: 00:00。

Example: `$SMS,000000;W038,08:00,20:00;! Turn on time:08:00, turn off time:20:00。`

### 13. Belt on/off alarm

- After connected with the belt, tracker will send warning to all of the authorized phone numbers and send alarm data to service;
- After unconnected with the belt or belt has been cut, tracker will send warning to all of the authorized phone numbers and send alarm data to service.

Note: after connected with the belt, tracker only can be turned on and can not be turned off.

### 14. Leave the home alarm

The Home Base unit has been in a wireless transmission mode.

When the location fails, the tracker uses the WIFI function to search the home base unit.

If the home base unit has been searched, the tracker send " A list of the names of the home base unit " to the platform .

When the home base unit have been detected, the tracker GPRS is turned off

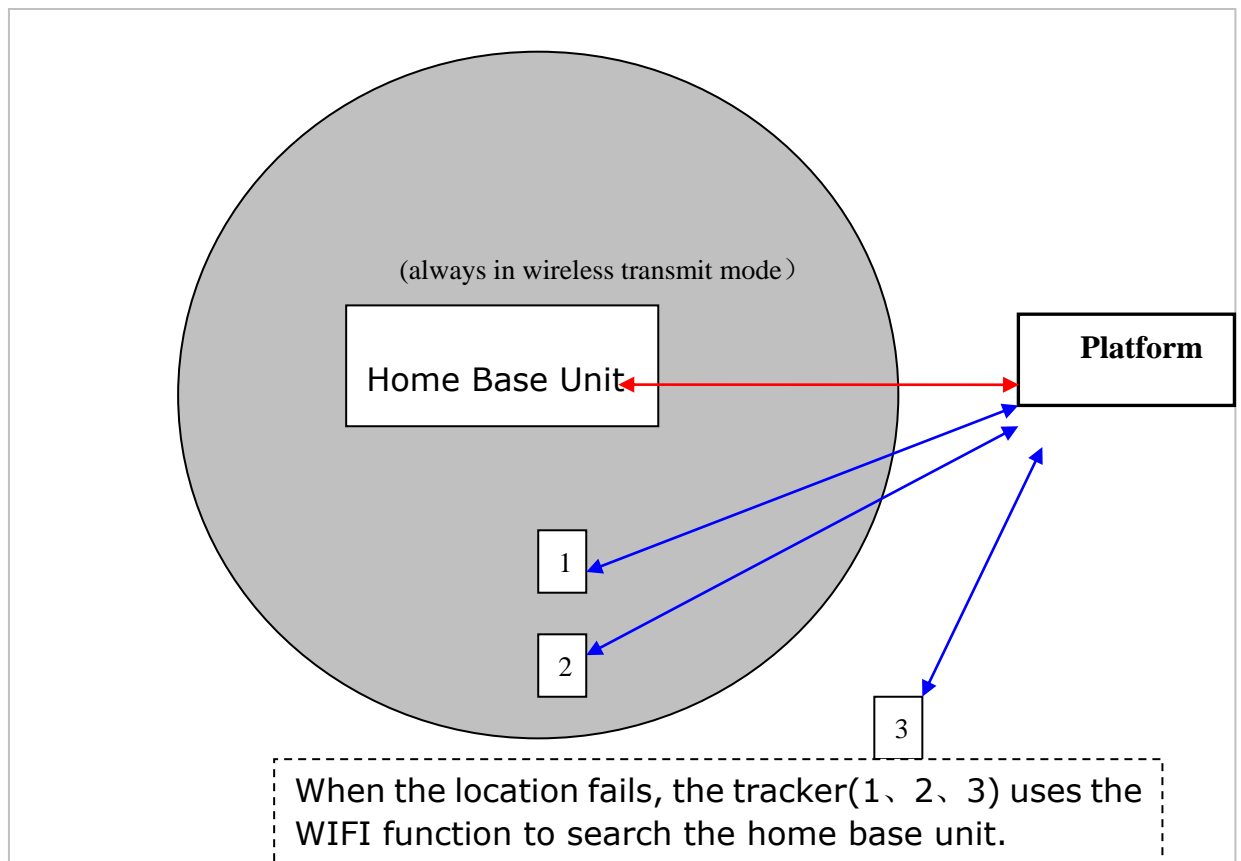

Description: 1,2,3 represents three different trackers. The gray area is a wireless transmission range of the Home Base unit.

## 4.Problems & Diagnostics



<b>Cannot switch on</b>	
<b>Possibility</b>	<b>Solution</b>
Power switch operation's problem	Make sure press the power switch for 5 seconds or longer
Low battery	Charging for 2.5 – 3 hours
<b>Not reply SMS</b>	
<b>Possibility</b>	<b>Solution</b>
Blue light is always on	Make sure tracker can receive the strong GSM signal Check SIM card installation, insert again if necessary Replace a new SIM if necessary
GSM network is busy	Wait for SMS. Sometimes GSM networks are slow during peak time or when they have equipment problems.
Password or SMS format is wrong	Double check password or SMS format, password and format must be right
Not enough SIM balance	Replace SIM card or check balance value
Low battery	Please do charging
<b>green light is 1s on and 1s off</b>	
<b>Possibility</b>	<b>Solution</b>
The tracker has already blocked the GPS signal	Move the tracker to open area w/o any tall building, tree and heavy raining. Those can shield GPS signal
GPS signal is weak	Place the GPS internal antenna face to the sky
Low battery	Please do charging
<b>No GPRS connection</b>	
<b>Possibility</b>	<b>Solution</b>
SIM card cannot supports GPRS function	Enable SIM's GPRS function
GPRS function is disabled	Enable the GPRS function
Incorrect IP or Port	Double check IP and Port and make sure they are correct,
GSM signal is weak	Move the tracker to a place with strong GSM signal